

LA-UR-7A-1466

Cont 741105--3.3

TITLE: IMPLOSION HEATING STUDIES IN THE SCYLLA 1B,
IMPLOSION HEATING, AND STAGED THETA PINCH EXPERIMENTS

AUTHOR(S): R. F. Gribble, J. E. Hammel, I. Henins, F. C. Jahoda,
R. Kristal, R. K. Linford, J. Marshall, K. F. McKenna,
A. R. Sherwood, and K. S. Thomas

SUBMITTED TO: Fifth Conference on Plasma Physics and Controlled
Nuclear Fusion Research in Tokyo, Japan, Nov. 11-15,
1974.

MASTER

By acceptance of this article for publication, the publisher recognizes the Government's (license) rights in any copyright and the Government and its authorized representatives have unrestricted right to reproduce in whole or in part said article under any copyright secured by the publisher.

The Los Alamos Scientific Laboratory requests that the publisher identify this article as work performed under the auspices of the U. S. Atomic Energy Commission.



NOTICE
This report was prepared as a result of work sponsored by the United States Government. Neither the United States nor the United States Atomic Energy Commission, nor any of their employees, nor any of their contractors, subcontractors, or their employees, makes any warranty, express or implied, or assumes any legal liability or responsibility for the accuracy, completeness or usefulness of any information appearing in this product or process disclosed, or represents that its use would not infringe privately owned rights.

Handwritten signature

**IMPLOSION HEATING STUDIES IN THE SCYLLA 1B,
IMPLOSION HEATING, AND STAGED THETA PINCH EXPERIMENTS***

**R. F. Gribble, J. E. Hammel, I. Henins, F. C. Jahoda, R. Kristal,
R. K. Linford, J. Marshall, K. F. McKenna, A. R. Sherwood and K. S. Thomas
University of California, Los Alamos Scientific Laboratory
Los Alamos, New Mexico**

ABSTRACT

Three experiments designed to study various aspects of implosion heating in the plasma density range (10^{14} - 10^{16} cm^{-3}) used in present theta pinches are described. Initial plasma studies show that, provided a sufficiently high preionization level ($> 10^{14}$ cm^{-3}) is achieved, plasma behavior is qualitatively the same over a range of two in initial magnetic field use and a range of four in initial gas fill. The implosion phase is characterized by rapid changes in magnetic field diffusion rates, the plasma resistivity decreasing rapidly with time. During the implosion some of the plasma density observed is moving ahead of the magnetic piston. Magnetic field gradients occur in the region outside the area of measurable plasma density implying the presence of hot, low density plasma in this region. In experiments where the external magnetic field decreases before the maximum compression of the plasma column, secondary breakdown occurs at the discharge tube wall which slows the rate at which magnetic flux diffuses out of the discharge tube.

*Work performed under the auspices of the U.S. Atomic Energy Commission

**IMPLOSION HEATING STUDIES IN THE SCYLLA 1B,
IMPLOSION HEATING, AND STAGED THETA PINCH EXPERIMENTS**

**R. F. Gribble, J. E. Hammel, I. Henins, F. C. Jahoda, R. Kristal,
R. K. Linford, J. Marshall, K. F. McKenna, A. R. Sherwood and K. S. Thomas
University of California, Los Alamos Scientific Laboratory
Los Alamos, New Mexico**

1. INTRODUCTION

For energy economy and stability reasons, future theta pinch devices will need a plasma which fills a sizable portion of the compression coil. A fast radial implosion will be used to produce a thermonuclear plasma having a diameter of one-third or more of the coil diameter. Three different experiments have been built to study various aspects of implosion heating in the plasma density range (10^{14} cm⁻³ to 10^{16} cm⁻³) used in present theta pinches.

2. EXPERIMENTS

2.1. Scylla 1B

Scylla 1B is a conventional theta pinch built of Scyllac components. The energy from the 75 kV, 100 kJ capacitor bank is fed to the 22 cm i.d. 1-m-long theta pinch coil at two points. Operation of the main bank from 40 kV to 70 kV produces vacuum E_0 's from 0.7 kV/cm to 1.2 kV/cm at the inner wall of the 20 cm i.d. discharge tube. The experiment was designed to study the implosion process in the E_0 range found in past and present Scylla type theta pinches.

2.2. Implosion Heating Experiment

The 1-m-long Implosion Heating Experiment (IHX) uses new high voltage technology to produce an initial rise of the magnetic field (dB/dt) which is 2-3 times greater than the maximum dB/dt in the Scylla 1B experiment. IHX is similar in geometry to the high voltage theta pinches [1,2,3] which studied the implosion process at initial plasma densities of 10^{12} - 10^{13} cm^{-3} . The Implosion Heating Experiment requires, however, a different high voltage power source because the higher initial plasma densities ($\sim 10^{15}$ cm^{-3}) cause a lower plasma impedance during the implosion phase. The magnetic field inside the 40 cm i.d. discharge tube is produced by four pulse-forming networks (PFN). A circuit diagram of one of the PFN's is shown in Fig. 1. Each of the PFN's is pulse charged from a 45 kJ capacitor bank in 1.3 μ sec. The magnetic field in the main coil rises to 10 kG in 140 nsec (a time much shorter than the 500-600 nsec run-in time) and remains almost constant for the lifetime of the implosion process.

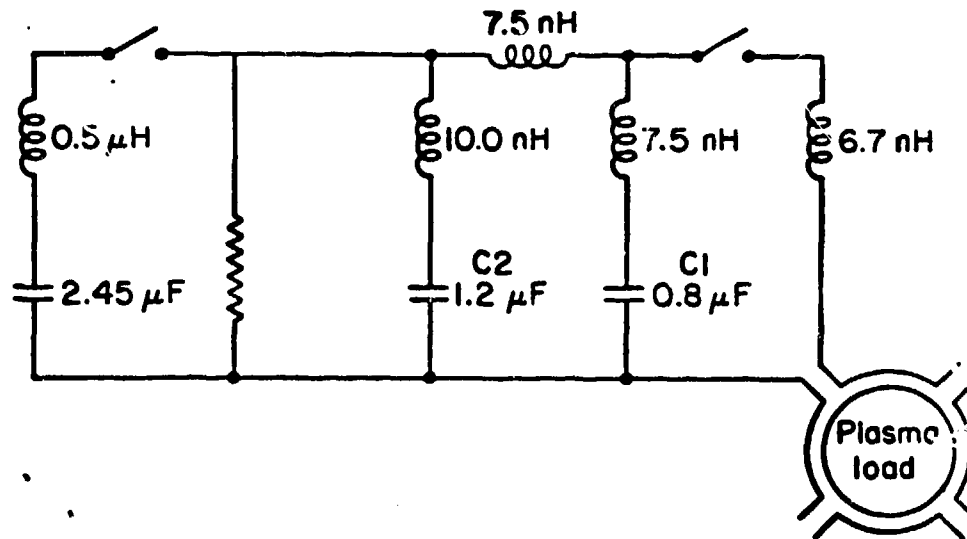

Fig. 1. Circuit diagram of the Implosion Heating Experiment.

2.3 The Staged Theta Pinch Experiment

The Staged Theta Pinch Experiment also uses new high voltage technology to produce a higher dB/dt than present theta pinches. In addition it is designed to use separate capacitor banks for the initial implosion heating and the subsequent compressional heating and confinement of the plasma. The implosion bank is divided into two independent parts which allows the time history of the implosion magnetic field to be varied (field programming). At the end of the initial implosion the plasma is overcompressed (plasma pressure > magnetic field pressure). If the magnetic field is reduced while the plasma expands and then raised again before the plasma contacts the discharge tube wall, the plasma does less work on the magnetic field during expansion and a higher final plasma temperature results. The layout of the Staged Theta Pinch (STP) in the experimental area is shown in Fig. 2 and a circuit diagram of the circuit which feeds one side of a 0.9 m section of the main coil is shown in Fig. 3. The implosion magnetic field in the 4.5-m-long experiment is generated by two 75 kJ, 125 kV capacitor banks. Except for length, the coil and discharge tube geometry are the same as in Scylla 1B.

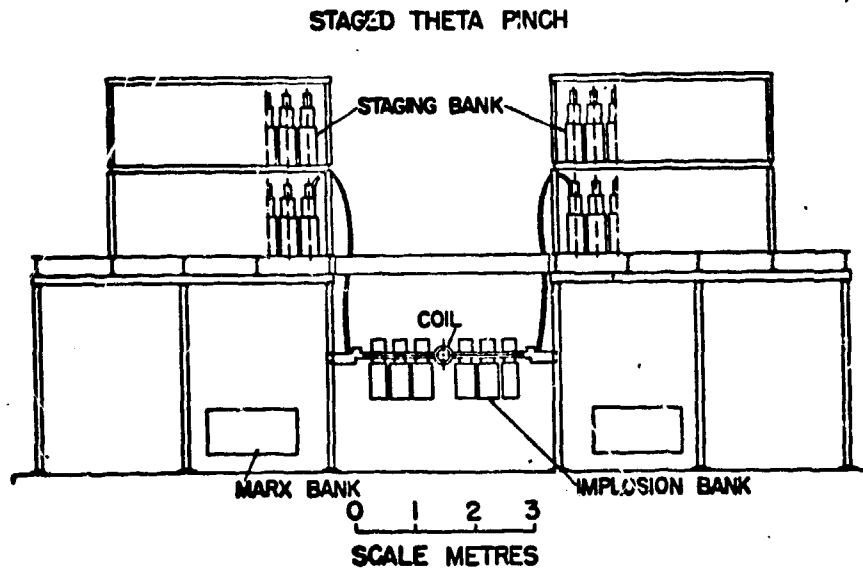

Fig. 2. Layout of the Staged Theta Pinch experiment in the experimental area.

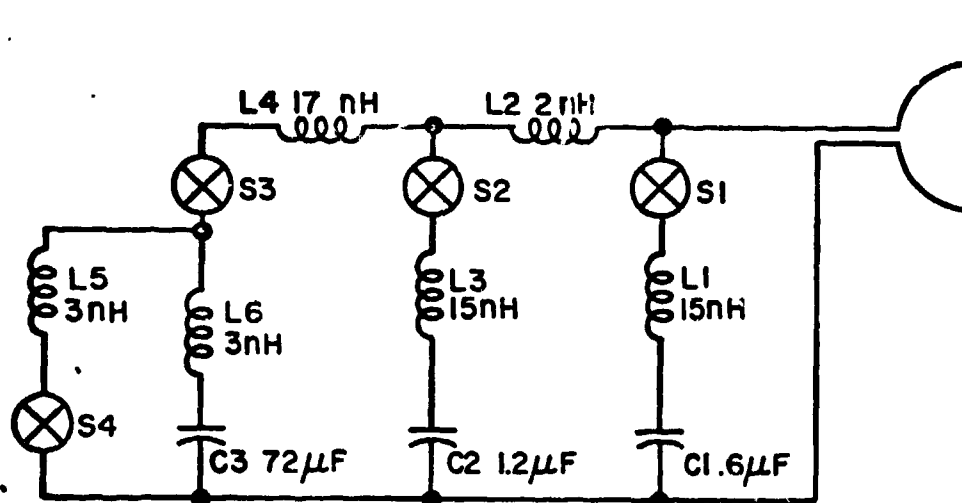

Fig. 3. Circuit diagram of one section of the Staged Theta Pinch experiment.

Plasma confinement and a small amount of adiabatic heating are supplied by two 350 kJ, 50 kV staging banks which are triggered after the plasma is formed. Initial implosion studies on the effects of field programming are being conducted on a 0.9 m section of the experiment.

3. EXPERIMENTAL RESULTS

Plasma results have been obtained from the Scylla 1B experiment and the 0.9-m section of the Staged Theta Pinch experiment. For initial plasma studies the STP section was operated with just the first part of the implosion circuit. This caused the main magnetic field to have the form of a slightly damped ringing L-C discharge modified by plasma effects. Two sizes of main bank capacitors were used,

0.2 and 0.4 μF ; this gave a magnetic field during the first half cycle which was a slightly distorted sine wave with half periods of 500 nsec and 800 nsec respectively. On both experiments plasma properties were studied over about a factor of two in main bank voltage, from 5 m torr to 20 m torr initial D_2 gas filling, and over a range of initial preionization levels. Although the STP section operated at higher voltages (up to 100 kV), initial dB/dt 's were similar to Scylla 1B due to the higher source impedances in the STP section. This was caused by the type of spark gap switch (a modified Scyllac gap) used for the initial plasma studies. (The final design will have a source inductance which is approximately a factor of two lower.) The main difference between the two experiments was in the shape of the magnetic field waveform. In Scylla 1B the field continued to rise after the initial implosion reaching its peak in 1.25 μsec while for the STP section the external field started decreasing before the initial implosion was over.

Plasma properties were measured principally with magnetic probes, interferometers and plasma luminosity detectors. Internal magnetic probes may be used in theta pinches in this density and temperature range for the short times involved in the implosion process. These probes give spatially and time resolved magnetic field profiles. Internal magnetic probes were inserted both radially (Scylla 1B) and end-on (STP) into the discharge vessel and the results of the two different arrangements agreed. Also, the internal probe measurements agreed with external total flux measurements from magnetic pick-up loops which enclosed the discharge tube. Holographic interferometry with a sensitivity $\approx 3 \times 10^{-14} \text{ cm}^{-3}$ gave spatial distributions of plasma with a time resolution limited only by the transit time of the laser pulse. A HeNe laser interferometer operating at 3.4 μm in the coupled cavity mode was used to study the preionization levels. Plasma luminosity measurements were made with a framing camera (Scylla 1B) and a streak camera (STP).

The following characteristics of plasma behavior are observed:

a. In both experiments there are two different plasma regimes. The operating conditions giving rise to the two regimes differ only in preionization level. For low preionization levels ($< 5 \times 10^{13} \text{ cm}^{-3}$, the sensitivity limit of the interferometer used to measure preionization levels) rapid magnetic field penetration is observed, plasma implodes at the same rate as the magnetic field penetrates, and a plasma with a relatively low β ($\beta < 0.6$) is formed. At higher preionization levels ($> 10^{14} \text{ cm}^{-3}$) magnetic field penetration is about a factor of 2 slower, plasma is observed moving ahead of the magnetic piston and a high β ($\beta \approx 1$) plasma is formed. In the latter case the only magnetic fields observed on the discharge tube axis are the result of compression of residual magnetic fields resulting from the preionization process. All the following results are for machine operation in the second regime (high preionization level). Plasma results for one set of operating conditions in Scylla 1B (40 kV main bank, 10 m torr initial gas fill, preionization level $\approx 10^{14}$) have been published.[4] Figures 4 and 5 show results for a 55 kV main bank voltage. Figure 4 shows interferograms taken at six times during the implosion phase. Measurements of particle inventories after plasma column formation show that almost all, if not all, of the initial gas fill has been swept up by the magnetic piston. Figure 5 shows combined density and internal magnetic field measurements at six times during the implosion. The results are typical of those obtained on both experiments throughout the range of dB/dt and initial gas fill investigated. Only the time scale of the implosion process changed, the implosion, as expected, being more rapid at higher dB/dt and lower initial gas fill.

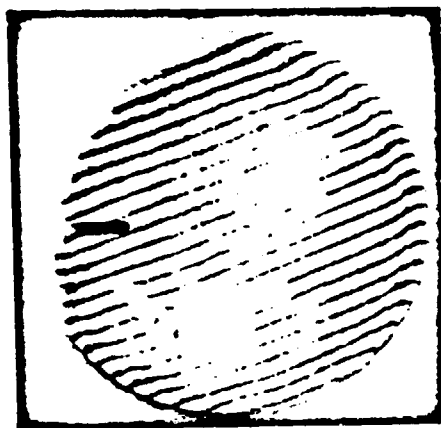

$t=100\text{nsec}$



$t=335\text{nsec}$



$t=200\text{nsec}$



$t=360\text{nsec}$



$t=275\text{nsec}$

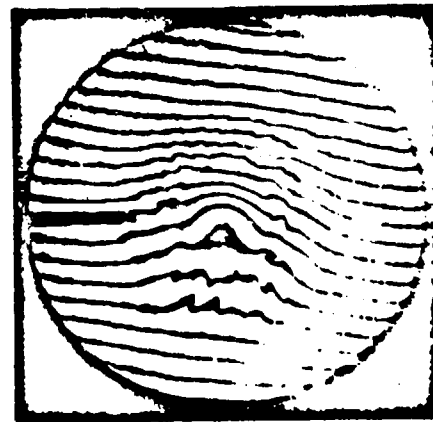

$t=410\text{nsec}$

Fig. 4. Time sequence of interferograms taken during the plasma implosion in the Scylla 1B experiment.

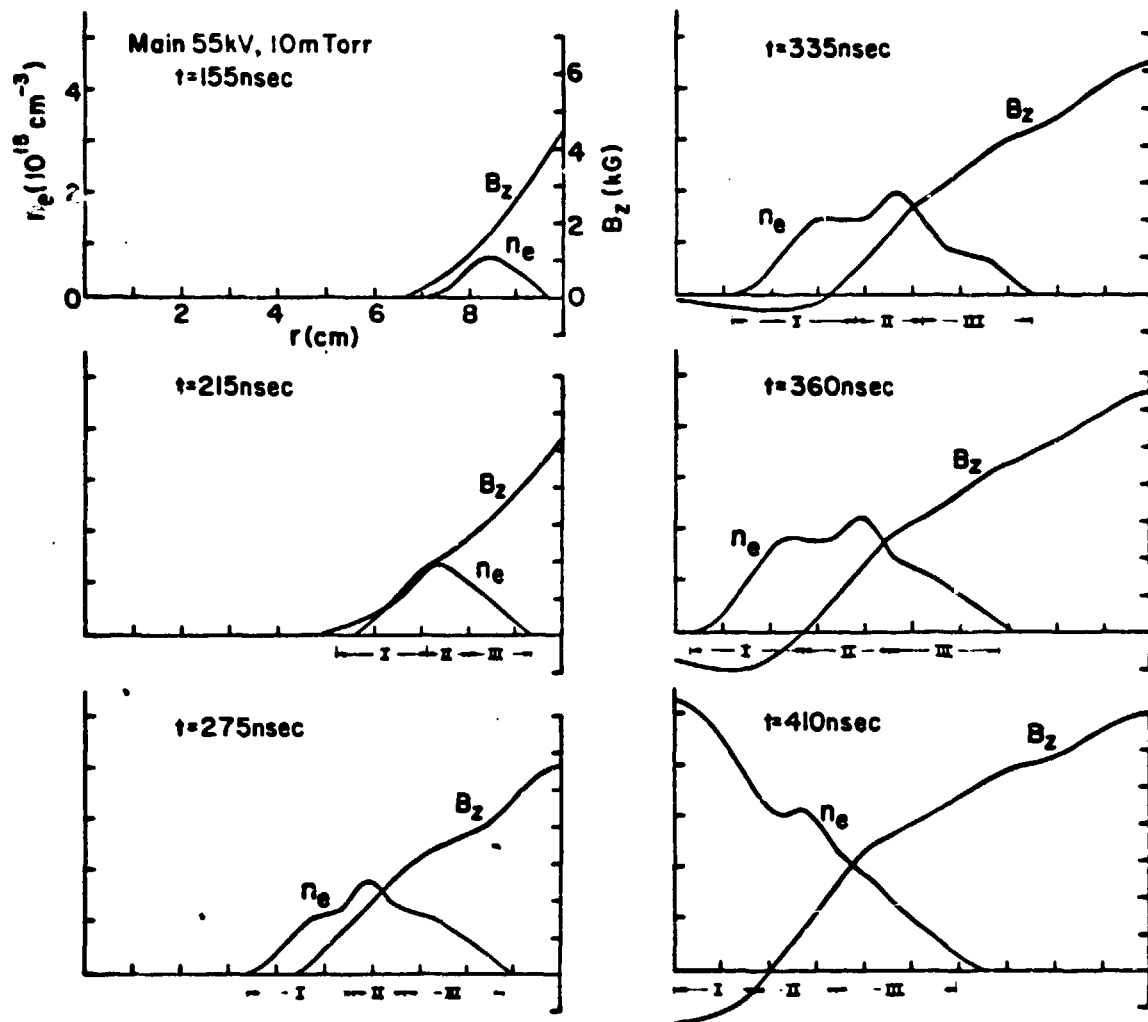

Fig. 5. Implosion profiles of the plasma density $n_e(r)$ and magnetic field $B_z(r)$ at fixed times reduced from interferograms and magnetic-field-probe data.

b. During the implosion two luminous rings appear on both framing and streak camera pictures. Figure 6 shows end-on framing pictures at three times during the implosion phase. The inner ring (Region I, Fig. 5) is structureless and corresponds to the plasma density front. The outer ring (Region III, Fig. 5) shows a flute structure. The structure occurs on the trailing edge of the observable density profile. Simultaneous interferograms and framing pictures show that this flute structure is the same as can be seen on the outer edges of the density profile in Fig. 4. The dark band (Region II, Fig. 5) corresponds to the peak of the density profile. The position of the luminous rings is shown as a function of time in Fig. 5. After the density front reaches the discharge tube axis the inner luminous region disappears. The outer ring also dims and loses its structure at about the time of maximum compression of the plasma column. The

disappearance of the flute structure is illustrated in Fig. 7 which shows interferograms of the plasma column during implosion and just after peak compression.

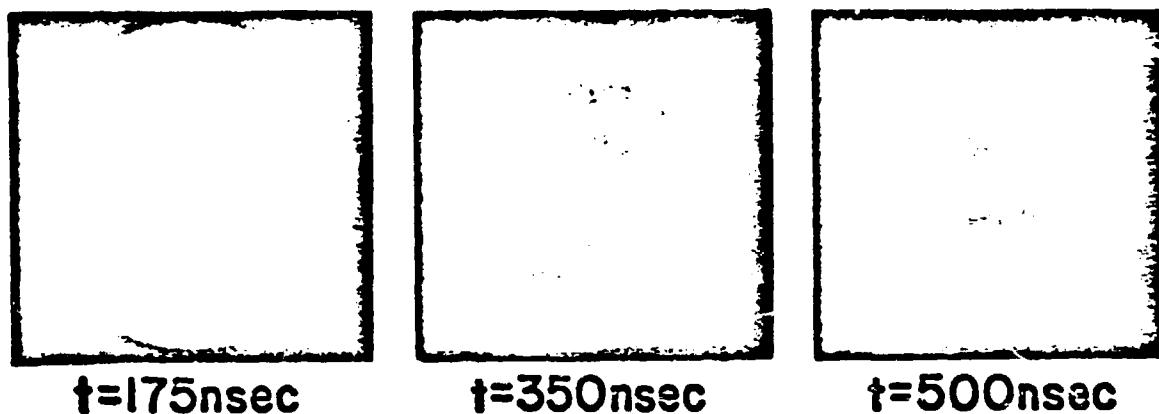

Fig. 6. End-on framing camera pictures of plasma luminosity at three times during the implosion phase in the Scylla 1B experiment.

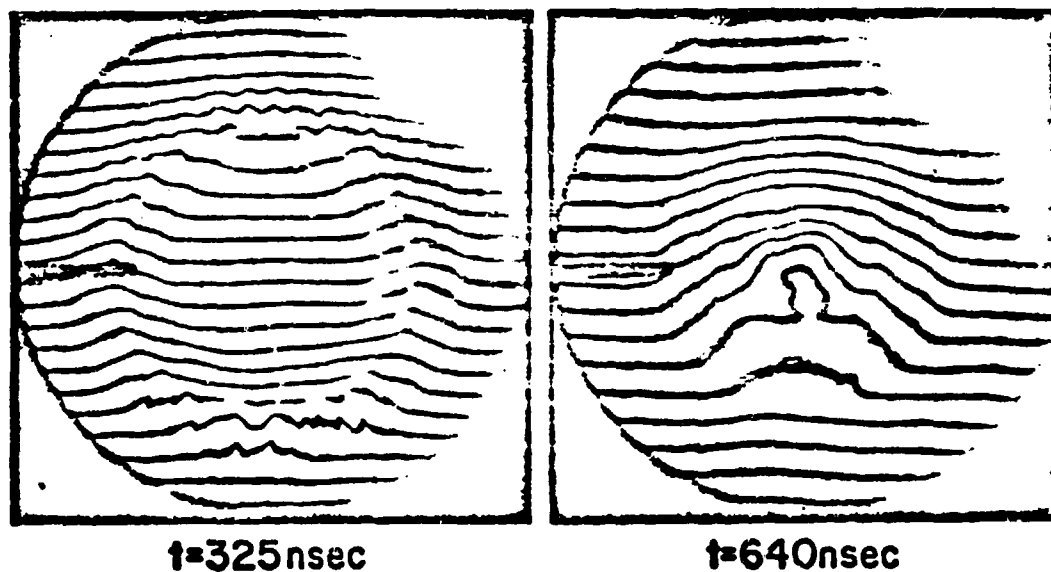

Fig. 7. Interferograms of Scylla 1B plasma during and after implosion phase illustrating the disappearance of the flute structure.

c. During the implosion phase magnetic field gradients are observed in the region outside the area of measurable plasma density, indicating the presence of plasma in this region. The background fringes are straight outside and in front of the imploding density ring which gives a value for the plasma density of less than $3 \times 10^{14} \text{ cm}^{-3}$. (The preionized plasma is below the sensitivity limit of the interferometer.) Thus, a high temperature for the plasma outside the observable

plasma column is implied by the low value for plasma density and the large gradients in magnetic field pressure. The magnetic field gradients are qualitatively the same for all operating conditions in both experiments but become larger for higher voltage operation to the point where it is difficult to define a magnetic piston thickness.

In the Scylla 1B experiment the magnetic field gradients disappear after the formation of the main plasma column. In the STP section, where the external field starts decreasing before the time of maximum compression, the magnetic field just inside the discharge tube wall is the same as the external magnetic field until just after the peak of the magnetic field in the first half cycle. After this time small deviations ($< 10\%$) occur until the time of secondary breakdown (discussed below). Between the wall and the outer edge of the observable plasma column the magnetic field gradient is almost uniform, the magnetic field having a value at the wall equal to the external magnetic field and a value at the outer edge of the observable plasma column which is almost constant in time and equal to approximately one-half the peak value of the external magnetic field during the first half cycle.

d. Secondary breakdown at the quartz discharge tube wall occurs in both experiments. In the STP sector this breakdown leads to large differences between the value of the magnetic field just inside the discharge tube wall and the external magnetic field and greatly decreases the rate at which magnetic flux diffuses out of the discharge tube. The breakdown occurs approximately 700 nsec after discharge initiation. In Scylla 1B the breakdown appears as luminosity at the discharge tube wall. This luminosity exhibits a flute structure as it moves in toward the discharge tube axis but does not appear to distort the magnetic field profiles.

4. DISCUSSION

In the range of initial conditions studied in these experiments to date, plasma performance at sufficiently high preionization levels ($> 10^{14} \text{ cm}^{-3}$) remains qualitatively the same. The implosion is characterized by an initial fast penetration of the external magnetic field. This occurs for approximately 100-150 nsec and the field diffusion rate implies a plasma resistivity during this time which is much higher than classical. The resistivity in the measurable plasma column drops rapidly with time. This is indicated by the fact that the residual magnetic field left in the preionized plasma is compressed by the imploding plasma and by the fact that the total amount of magnetic flux imbedded in the observable plasma remains approximately constant during the later part of the implosion. Where definable, the magnetic piston is 2-3 cm thick, almost as thick as observed in experiments operating 2-3 orders of magnitude lower in initial plasma density.[1,2,3]

During the implosion a flute structure develops, probably caused by a Rayleigh-Taylor instability, which disappears by the time of peak compression of the plasma column.

The presence of low density, high temperature plasma in the region outside the observable plasma column is indicated by large radial magnetic field gradients in this region. The origin of this plasma is unknown. It may be due to plasma left behind by the flute instabilities, some residual gas fill which is

ionized after passage of the imploding plasma, or material which comes off the discharge tube wall. This low density plasma would be expected to cool rapidly due to thermal conduction to the ends of the theta pinch, and this may explain the lower field gradients for the cases where the implosion is slower.

The cause of the formation of a current sheath at the wall 0.5-1 μ sec after discharge initiation is unknown. This process may start at the time when the plasma is in contact with the discharge tube and take some time to develop. In the STP section the breakdown may be due to low density plasma being carried to the wall because of the decrease of magnetic flux inside the discharge tube.

5. ACKNOWLEDGEMENTS

The authors wish to thank C. Nielson, F. L. Ribe and G. A. Sawyer for helpful discussions about the experiments and J. N. Downing, A. R. Jacobson and E. J. Zimmerman for help in collecting and analyzing the data. Work was performed under the auspices of the United States Atomic Energy Commission.

REFERENCES

- [1] HOTHKER, K., et al., Proceedings of the Sixth European Conference on Controlled Fusion and Plasma Physics, Moscow, U.S.S.R., 1973 (U.S.S.R. Academy of Sciences, Moscow, 1973) 299.
- [2] KEILHACKER, M., et al, Proceedings of the Sixth European Conference on Controlled Fusion and Plasma Physics, Moscow, U.S.S.R., 1973 (U.S.S.R. Academy of Sciences, Moscow, 1973) 307.
- [3] DOVE, W. F., Phys. Fluids 14 (1971) 2359.
- [4] MCKENNA, K. F., KRIS'LAL, K., THOMAS, K. S., Phys. Rev. Letters 32 (1974) 409.

- Fig. 1.** Circuit diagram of the Implosion Heating Experiment.
- Fig. 2.** Layout of the Staged Theta Pinch experiment in the experimental area.
- Fig. 3.** Circuit diagram of one section of the Staged Theta Pinch experiment.
- Fig. 4.** Time sequence of interferograms taken during the plasma implosion in the Scylla 1B experiment.
- Fig. 5.** Implosion profiles of the plasma density $n_e(r)$ and magnetic field $B_z(r)$ at fixed times reduced from interferograms and magnetic-field-probe data.
- Fig. 6.** End-on framing camera pictures of plasma luminosity at three times during the implosion phase in the Scylla 1B experiment.
- Fig. 7.** Interferograms of Scylla 1B plasma during and after implosion phase illustrating the disappearance of the flute structure.